

Data Transmission Systems

POWERTRANS® Ib (RS 485, DH+)

Program 0512

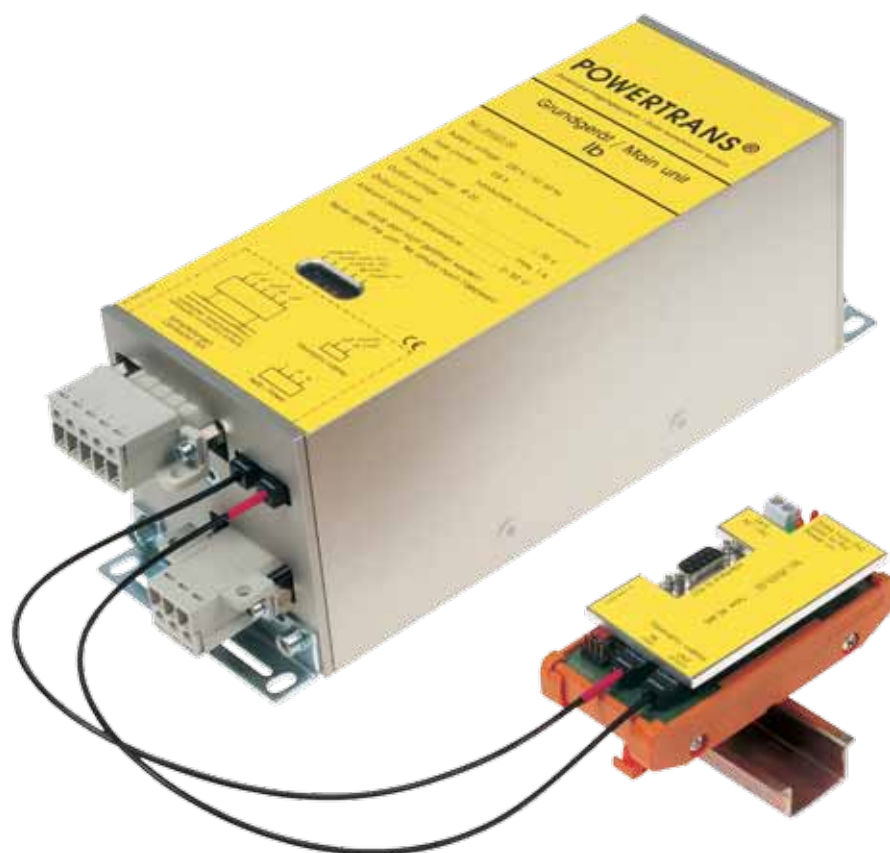

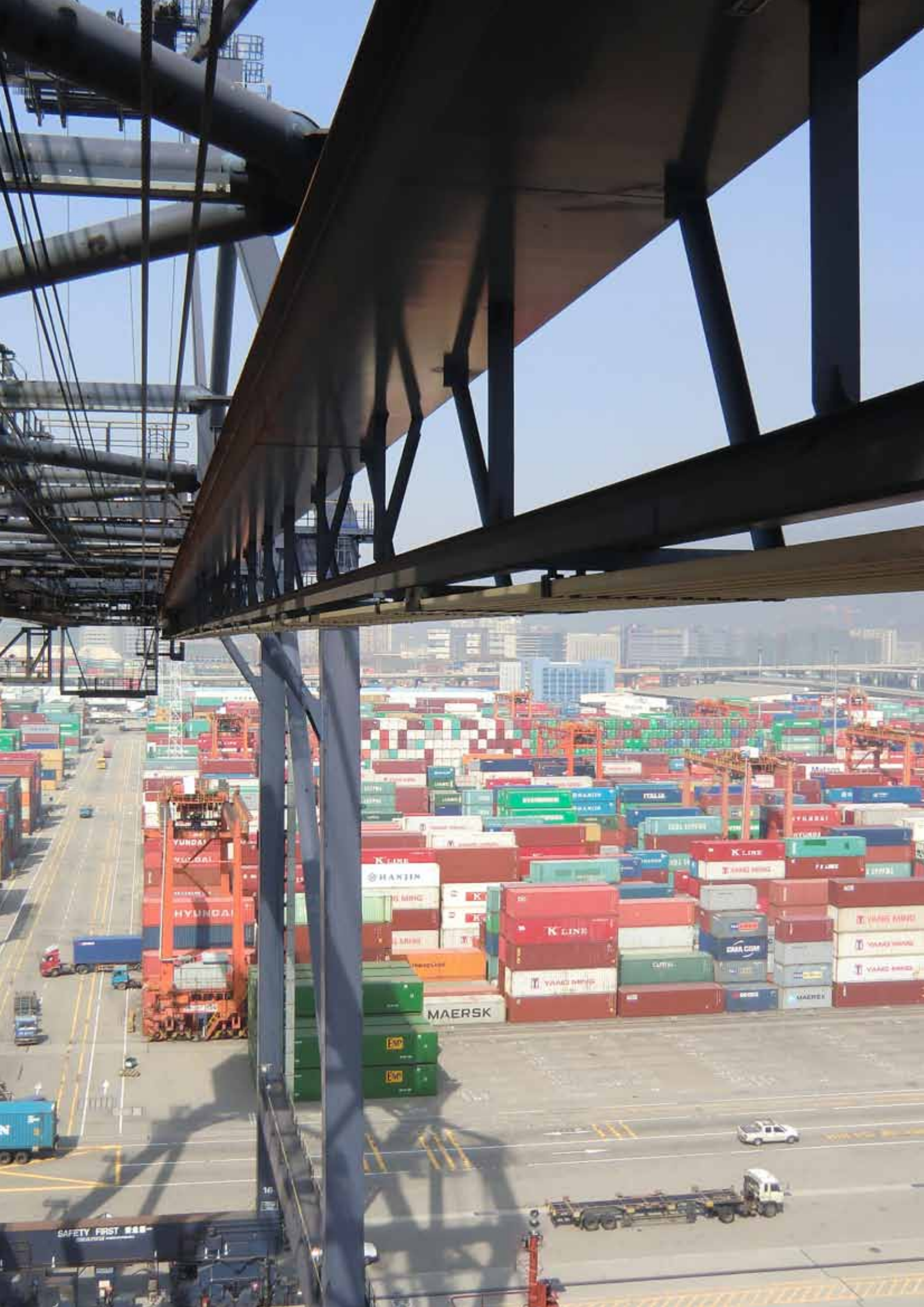

Contents

Fundamentals

| | |
|---|---|
| Range of Application: Data Transmission System for Mobile Consumers | 4 |
| Operational Principle | 4 |
| Typical Data Interfaces of the Powertrans® Ib Unit | 5 |
| Terminators for Conductor Rails and Cables | 5 |
| Bus Terminators of the Bus Cable | 5 |

Types of Operation

| | |
|--|---|
| Half Duplex (2-poles), e.g. Profibus | 6 |
| Full Duplex (4-poles), e.g. RS422 | 6 |

Definition

| | |
|--|---|
| General | 7 |
| Bus Structure: Connecting Structures of Information Processing Systems | 7 |

System Components

| | |
|--|----|
| Powertrans® Set 230V / RS 485 | 8 |
| Powertrans® Ib Basic Unit for Interfaces RS 485/422/232, DH+ | 8 |
| Powertrans® Ib Interface for Switchboard Assembly on Support Rail TS35 | 8 |
| Powertrans® Ib Pair of Optical Fibers | 9 |
| Terminator/Conductor Rail – in a Case | 9 |
| Connectors/Conductor Rail – without Case for Switchboard Installation | 9 |
| Terminator/Conductor Rail – without Case for Switchboard Installation on Support Rail TS35 | 9 |
| Technical Data | 10 |

Project, Assembly and Starting Operation

| | |
|--|----|
| Maximum Lengths for Conductor Rails | 11 |
| Recommended Configuration of the Conductor Rail | 11 |
| Bus Terminators | 11 |
| System Examples 1 | 11 |
| System Examples 2 | 12 |
| Electric Connection (also see standard connection diagram) | 12 |
| Shielding | 12 |
| Standard Connection Diagram: Application Example for Half Duplex (2 poles) | 13 |
| Indicators / (LED) | 14 |
| Indicator / LED in Case of Disturbance | 14 |
| Cause for Disturbance | 15 |
| Elimination of Disturbance | 15 |
| Special Requirements for DH+ Interface Module | 15 |
| Volume of Delivery | 16 |
| Personal Security | 16 |
| Equipment Security | 16 |
| Transport Damage | 16 |
| Mounting of the Basic Unit and Interface | 16 |
| Questionnaire | 17 |

Program Overview

| | |
|---------------------------|----|
| Conductor Rails | 18 |
| General Hints | 18 |

Fundamentals

Range of Application: Data Transmission System for Mobile Consumers

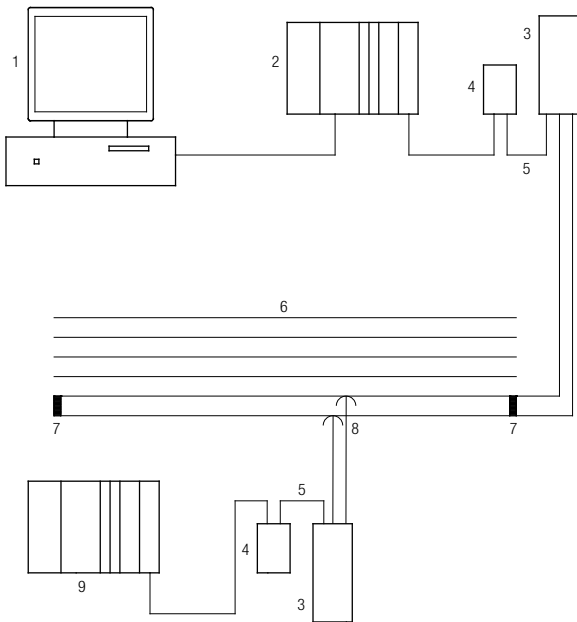

1. Stock control computers
2. Automation computers (PLC)
3. Powertrans® Ib basic unit
4. Powertrans® Ib interface
5. Powertrans® Ib pair of optical fibers
6. Conductix-Wampfler conductor rail
7. Conductix-Wampfler terminator / conductor rail
8. Conductix-Wampfler double current collector
9. Decentralized peripheral unit

Powertrans® Ib systems are used for Conductor rails in interiors, e.g. in

- High storage warehouses
- Crane systems
- Hoists
- Transport systems
- Hand-operated overhead conveyor systems
- Handling systems

Slip ring bodies in

- Rotary cranes, excavators
- Water treatment works
- Amusement rides
- Manipulators
- Packing machines

Cables for

- Cable reels
- Control cables
- Crane systems

Voltages or currents of the data signals on Bus systems are often too low to achieve a reliable and trouble-free data transmission. Sliding contact surfaces tend to form oxide layers and may cause short-time interruptions in contaminated environments. To achieve low and constant contact resistance between contact surfaces and current collector, Powertrans® Ib increases the power level of the data signals. In connection with double current collectors this allows a safe and reliable data transmission.

The increase of the signal level also produces a strong insensitivity to inductive and capacitive interference from neighboring conductors to the Bus system (e.g. on cable reels, festoons or longer supplies).

The transparent data transmission prevents relevant retardation times or long-time transmission records.

Reference systems with system connection to various automation computers with standard interfaces RS485, RS422, RS232 and DH+ are in operation.

Operational Principle

Connecting sockets

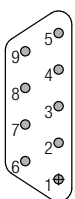

Sub-D

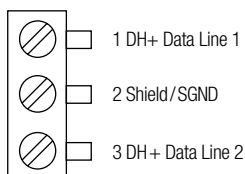

DH+

| Interface Connections | | | | |
|-----------------------|-----------|-------|-------|-------------|
| PIN | Sub-D | | | |
| | RS485 | RS422 | RS232 | DH+ |
| 1 | - | - | - | Data Line 1 |
| 2 | - | Rxd-P | - | SGND |
| 3 | Rxd/Txd-P | Txd-P | Txd | Data Line 2 |
| 4 | - | - | +12 V | - |
| 5 | SGND | SGND | SGND | - |
| 6 | +U | +U | - | - |
| 7 | - | Rxd-N | - | - |
| 8 | Rxd/Txd-N | Txd-N | Rxd | - |
| 9 | - | - | - | - |

On Powertrans® Ib the interface is connected to the compact basic unit by optical fibers. If the existing interface is changed, this presents the advantage that only the interface will have to be replaced. Moreover the basic unit can be removed from the interface, which is often placed near a PLC.

The PLC signals are electrically disconnected from sending and receiving by means of Opto-coupling components.

Each unit (basic unit, interface and pair of optical fibers) includes a sender and a receiver.

The sender increases the signal level of the interface signal from unit A to $\pm 70V$ (potential-free) for connection to the corresponding transmission medium.

The receiver of unit B reduces the signal level back to the appropriate interface level.

The units support different serial data forms, such as RS485, RS422, RS232 oder DH+.

All entries and/or exits are short circuit resistant.

For max. cable lengths use two-wire twisted and shielded cables according to the specifications of the PLC manufacturer.

A 9-pole Sub-D or DH+-clamp provides for the coupling of different interface signals. In general the transmission rate should be as low as possible, depending on the application. The specific determination of response times and repeating times during programming of the Bus system by the operator additionally supports a safe transmission of data. PLC adjustments for unshielded cables have to be set (RETRY-Level > 0).

Fundamentals

Typical Data Interfaces of the Powertrans® Ib Unit

RS485

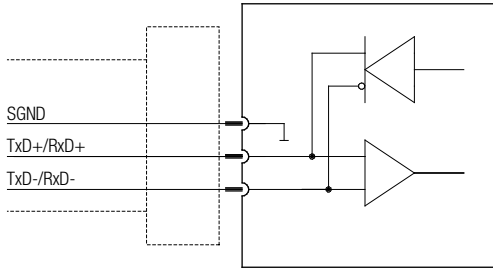

RS232

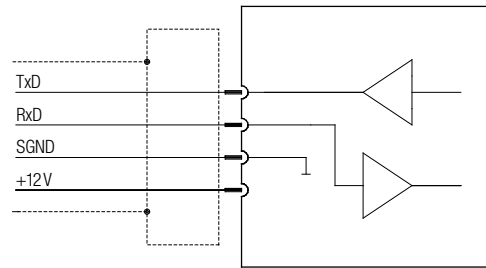

RS422

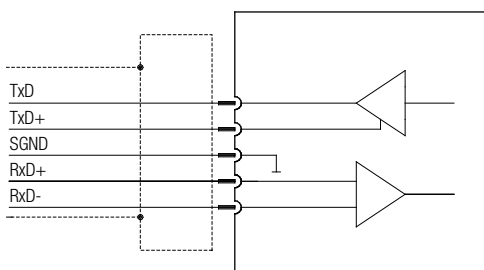

DH+

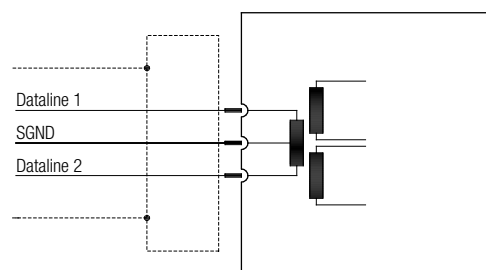

Terminators for Conductor Rails and Cables

Terminators help to reduce signal distortions that appear on conductor rails, slip rings and cables. The dimensions of the terminators are determined by the corresponding surge impedance of the transmission medium and are adjusted to the customer's specific line system. The Conductix-Wampfler engineers will be pleased to help you. The terminators can be mounted by choice in a plastic case or on a cooling body for switchboard applications. The Powertrans® Ib units should be installed as close as possible to the feeding point of the transmission length (e.g. conductor rail). For further information regarding assembly and electric connection of the Powertrans® Ib units please see the corresponding mounting instructions MV0512-0002-E.

Bus Terminators of the Bus Cable

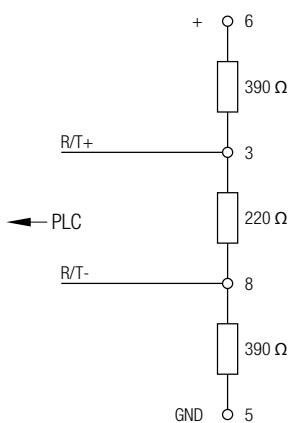

Bus terminators of the bus cable have to be installed according to the manufacturer's instructions for the installed control. There is no bus resistor on the interface. The application of converters (e.g. RS232 on RS485) requires bus terminators at the interfaces.

Bus terminators for RS485, e.g. Profibus

Types of Operation

The Conductix-Wampfler data transmission system is made up of Powertrans® lb units, conductor rail systems (e.g.) and the corresponding terminators/conductor rail. Powertrans® lb units can be used for both "Master" and "Slaves".

Half Duplex (2-poles), e.g. Profibus

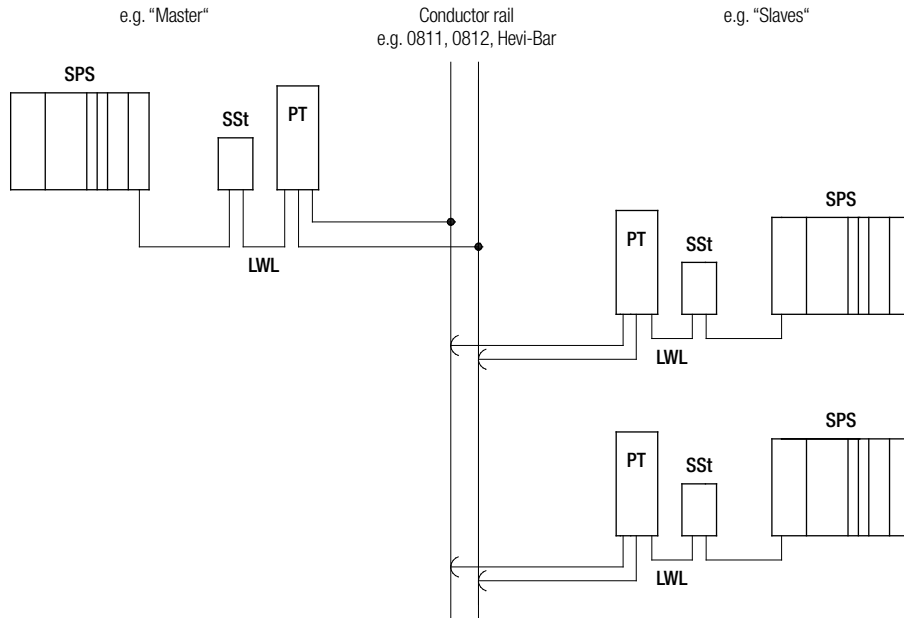

For extensive **central bus controls** with many mobile units the complete system must be divided into individual segments. Max. 15 units can be installed on one segment. In the "half duplex" operation (2 poles) the Master controls the Bus access.

Full Duplex (4-poles), e.g. RS 422

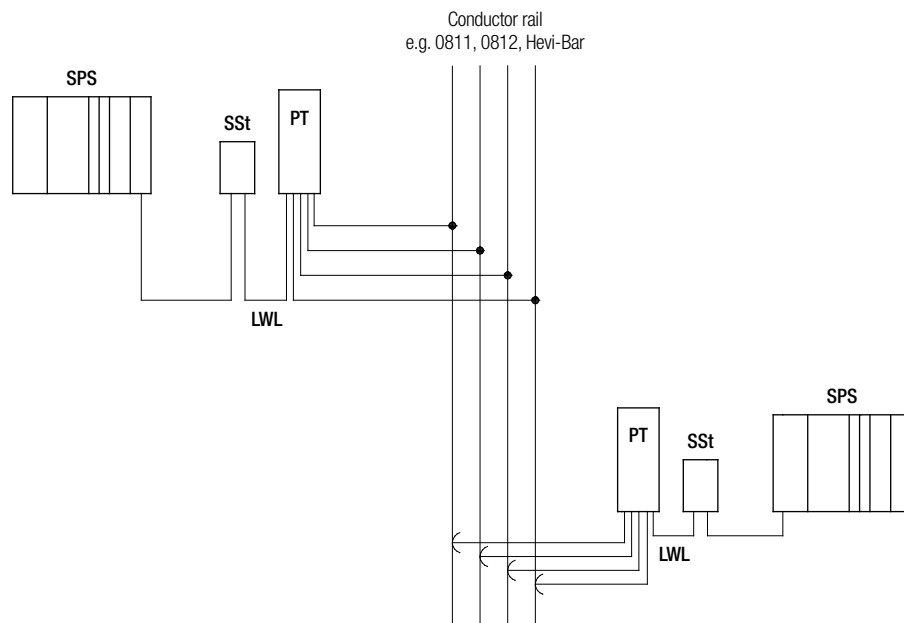

In the "full duplex" type of transmission all units, that are connected to the Bus system, can send or receive at the same time. This requires 4 conductor rail poles.

- PLC = Programmable Logic Control
- IM = Interface Module
- FOC = Optical Fibres Cable
- PT = Powertrans® Unit

Definition

General

| | |
|----------------------------------|---|
| Powertrans® | Registered trade mark by Conductix-Wampfler GmbH |
| Terminator/conductor rail | Resistance at conductor rail and/or cables to suppress signal reflections on cables |
| Bit | Binary digit. One bit is the smallest unit that is able to contain some meaningful information |
| Bus | Common data transmission line for the exchange of information |
| Data out | Data to PLC respectively personal computer (PC) active |
| Data in | Data from PLC respectively personal computer (PC) active |
| Data interface | Interchange point between 2 units with standard values for the physical cables Signal significance and process of the signal exchange Standard examples: RS 485, RS 422, RS 232, DH+ |
| Duplex | <u>Half duplex</u> ⇒ Data transmission in only one direction (send or receive) on 2 cables <u>Full duplex</u> ⇒ Send and receive data transmission on 4 (2+2) cables in both directions (at the same time) |
| Master | Controlling unit within one segment |
| Opto coupler | Component for the galvanic separation of electric circuits |
| Records | Definition of the data formats and control procedures for the communication between the units. |
| Point to point connection | Direct connection between 2 units for the exchange of information |
| Sequential | Interdependent sequence of orders |
| Slave | Controlled unit within one segment |
| PLC | Programmable Logic Control |
| RETRY Parameter | PLC parameter for adjusting the system in case of short-term loss of data. PLC settings for unshielded cables, e.g. conductor rails have to be set RETRY-Level > 0 |
| Signal-to-noise ratio | Difference between intelligence signal and fault signal level |
| Sub-D-socket | Standard plug and socket connection |
| Transparent transmission | Signals to be transmitted are only increased in their amplitude, with no relevant time delay |
| Central Bus control | A <u>Master</u> automation unit controls the Bus access (data exchange process) of the connected <u>Slave</u> automation units |

Bus Structure: Connecting Structures of Information Processing Systems

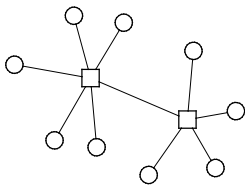

Star wiring

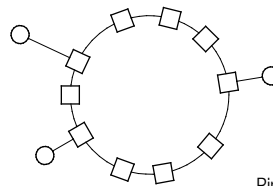

Ring wiring

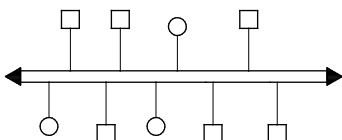

Bus wiring

- = Central unit
- = Participating unit

Set and System Components

Powertrans®-Set 230V / RS 485



Powertrans®-Set composed of:

- 1 x Basic unit 230V (051221-30)
 - 1 x Interface-module RS 485 (051231-22)
 - 1 x Pair of optical fibres cable 0,4m (051222-4004)
- Delivery incl. Mounting angle and Instruction manual

| Supply voltage | Type of operation | Protect. type | Order No. | Weight [kg] |
|----------------|-------------------|---------------|-----------|-------------|
| 230V - 50/60Hz | Half duplex | IP 20 | 3032433 | 3.5 |

Powertrans® Ib Basic Unit for Interfaces RS 485/422/232, DH+

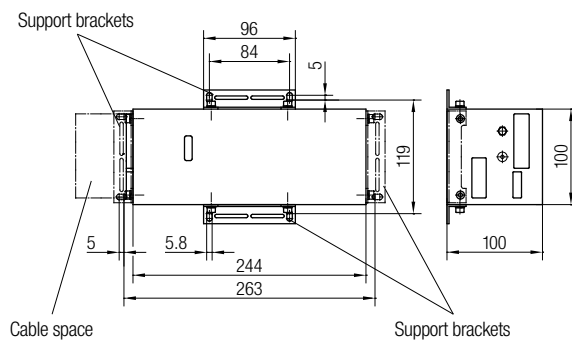

Delivery

Support brackets for front or longside installation enclosed.

| Supply voltage | Type of operation | Protect. type | Order No. | Weight [kg] |
|----------------|-------------------|---------------|-----------|-------------|
| 230V - 50/60Hz | Half duplex | IP 20 | 051221-30 | 3.2 |
| 115V - 50/60Hz | | | 051221-31 | |

Powertrans® Ib Interface for Switchboard Assembly on Support Rail TS 35

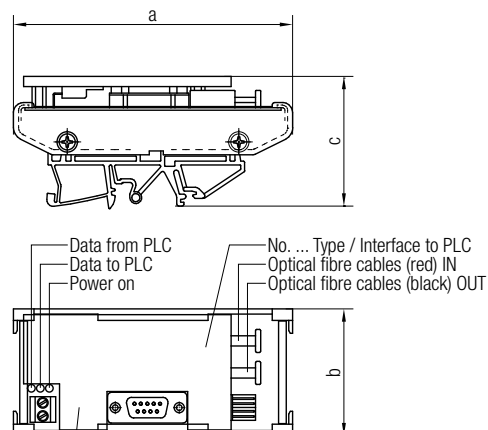

| Interface/standard | Supply voltage | Protection type | Order No. | Dimension [mm] | | | Weight [kg] |
|--------------------|----------------|-----------------|------------|----------------|----|----|-------------|
| | | | | a | b | c | |
| RS 485 | 24V AC/DC | IP 20 | 051231-22 | 109 | 50 | 50 | 0.15 |
| RS 422 | | | On inquiry | | | | |
| RS 232 | | | 051231-20 | 112 | 75 | 45 | |
| DH+ | | | | | | | |

System Components

Powertrans® 1b Pair of Optical Fibers



| Length [m] | Order No. | Length [m] | Order No. | Length [m] | Order No. | Length [m] | Order No. |
|------------|-------------|------------|-------------|------------|-------------|------------|-------------|
| 0.4 | 051222-4004 | 20 | 051222-4200 | 50 | 051222-4500 | 80 | 051222-4800 |
| 5.0 | 051222-4050 | 30 | 051222-4300 | 60 | 051222-4600 | 90 | 051222-4900 |
| 10.0 | 051222-4100 | 40 | 051222-4400 | 70 | 051222-4700 | | |

Terminator/Conductor Rail – in a Case

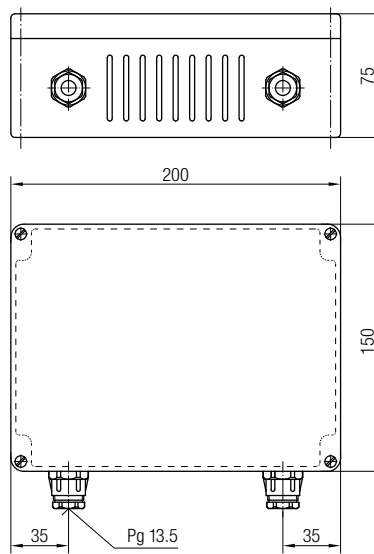

| Resistance value [Ω] | Order No. | Weight [kg] |
|----------------------|-------------|-------------|
| 150 | 051213-2201 | 0.5 |
| 330//330 | 051213-2203 | |
| 470//470 | 051213-2204 | |

Type on mounting plate

Connectors/Conductor Rail – without Case for Switchboard Installation

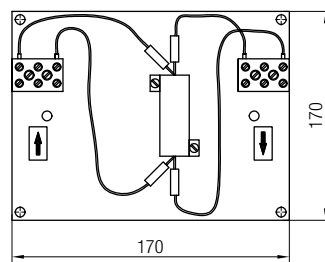
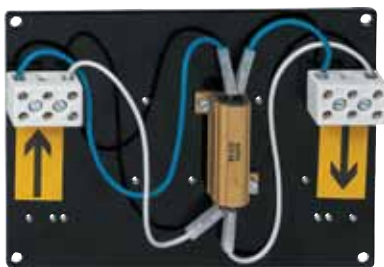

| Resistance value [Ω] | Order No. | Weight [kg] |
|----------------------|-------------|-------------|
| 150 | 051213-2101 | 0.25 |
| 330//330 | 051213-2103 | |
| 470//470 | 051213-2104 | |

Type on mounting plate

Terminator/Conductor Rail – without Case for Switchboard Installation on Support Rail TS35

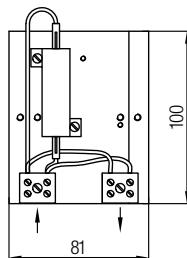

| Resistance value [Ω] | Order No. | Weight [kg] |
|----------------------|-------------|-------------|
| 150 | 051213-2112 | 0.25 |

Type on cooling body

System Components

Technical Data

Intended Use:

Communication between participants in industrial fieldbus networks with Profibus DP, Allen Bradley CH+ or RS 232 interfaces, via conductor rails or reels- and slip rings in indoor systems or protective (IP23) outdoor systems.

| Designation | Dimensions | Remarks |
|--------------------------------------|--|--|
| Possible data interfaces | RS485 (Profibus), RS422, RS232, DH+, etc. | Installation for support rails TS35 |
| Transmission rate | type 187.5 Kbit accordant to Profibus DP 12 Mbit Bus at a cable length of $l > 1000\text{m}$ (wireloop) | Up to 1.5Mbit, acc. to the system config 1000m wire loop is equivalent to 500m conductor rail length |
| Time response | no relev. time delay/real time | |
| Length of the system segments | typ. < 400 m, depending on the transmission rate | Longer lengths on inquiry |
| Data exchange | by 2 poles half duplex operation | Projecting for 4 poles Full duplex operation on inquiry |
| Driver | | |
| • No-load voltage | $\pm 70\text{ V}$ potential-free | Connecting cross section 0.75 – 2.5 mm ² , shielded |
| • Short-circuit current | 0.1 to 1A | |
| Receiver | | |
| • Input resistance | typ. 15 k Ω | |
| • Sensitivity | typ. 4 mA | |
| Bus unit per segment | Up to 15 | |
| Opto coupler | Insulation 3kV, 5 mm creep distance | |

Requirements for surroundings and conductor rail system:

- Double current collectors are mandatory (contact redundancy)
- Surroundings have to have low dust and no moisture influence
- PLC system has to be adjustable for communication via unshielded bus-cables

| Operating data | | |
|----------------------------|-------------------------------|--|
| Basic unit | | |
| • Supply voltage | 230V AC, $\pm 10\%$, 50/60Hz | Standard type; connecting cross section. max. 2.5 mm ² |
| | 115V AC, $\pm 10\%$, 50/60Hz | Special type; connecting cross section. max. 2.5 mm ² |
| • Power absorption | typ. 50VA, 9VA stand-by | |
| • Max. ambient temperature | 0°C to +50°C | |
| • Protection type | IP 20 | Higher protection type up to IP 65 carried out in the switchboard |
| Interface | | |
| • Supply voltage | 24V AC/DC, $\pm 10\%$ | Connecting cross section max. 2.5 mm ² |
| • Power absorption | 2VA | |

Project, Assembly and Starting Operation

Maximum Lengths for Conductor Rails (according to Profibus DP 12 Mbit standard)

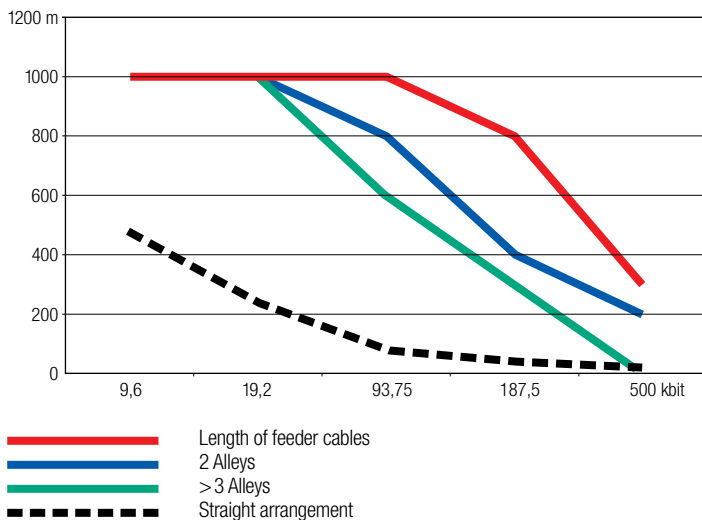

During system projecting it is required to observe among other items the maximum parameters for total length, length of feeder cable, number of participating units etc. The maximum values as well as some system examples are shown as follows, for complex systems please consult our engineers.

Maximum 15 mobile participating units can operate together with one stationary unit. A larger number of mobile participating units requires a segmentation of the system.

The stated lengths are the maximum possible lengths under optimum conditions (e.g. straight arrangement, one mobile participating unit, single-pole conductor rail, no contamination etc.) The type of system construction and above mentioned conditions may require a reduction of these lengths. The lengths of annular slip ring systems correspond to those with 3 alleys. If possible, this variation should however be avoided on account of reflections, i.e. with regard to electricity beginning and end should not be connected (pick-up guide for transfer points).

In case of center feed the length of the supply cable to the conductor rail is to be considered as the feeder cable.

Note: rail lengths and maximum data transfer rates are in accordance with the maximum values defined by the Profibus association. Depending on system surroundings, deviations can occur.

Recommended Configuration of the Conductor Rail

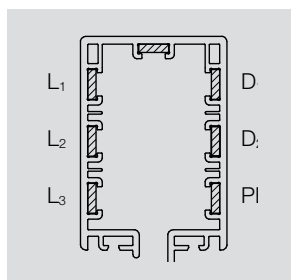

Enclosed conductor rail 0842

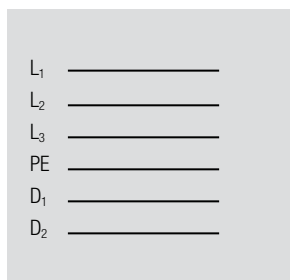

Single-pole conductor rail

Note:

if possible, keep data lines separated from energy-carrying lines.

Bus Terminators

| Arrangement conductor rail | Terminator [Ω] |
|---|----------------|
| Conductor rail straight, slip ring, annular | 150 |
| Conductor rail 2 alleys | 150 |
| Conductor rail 3 alleys | 330/330 |
| Conductor rail 4 alleys | 470/470 |

Arrangement of the bus terminators at the outlet of the stationary Powertrans® unit or at the beginning of the conductor rail and at the end of the conductor rail. It must be observed that the connecting points of the connection cables of terminators and connections are really at the end of the conductor rail.

System Examples 1

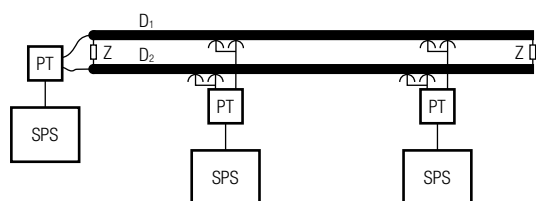

Straight arrangement with end feed

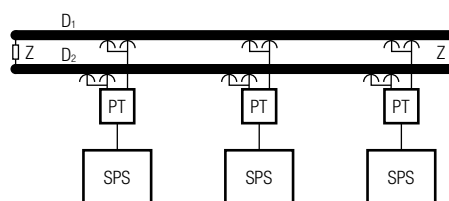

Straight arrangement with center feed

Project, Assembly and Starting Operation

System Examples 2

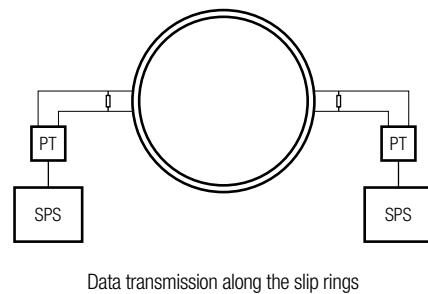
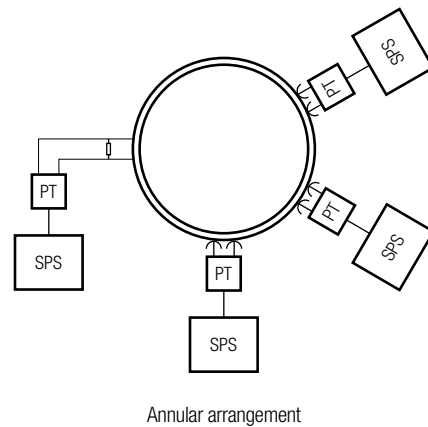
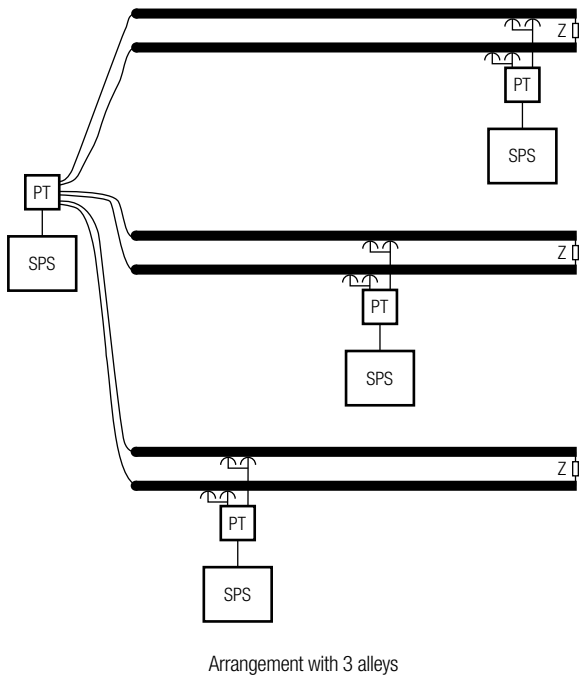

Electric Connection (also see standard connection diagram)

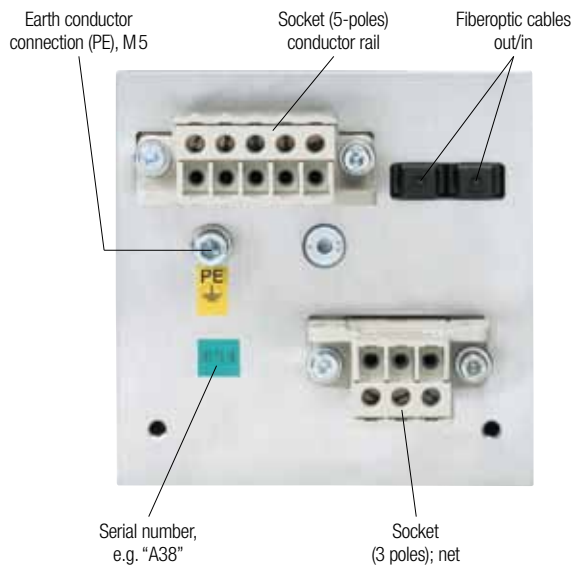

For operation without interference we recommend equipping the supply system with a line filter and a differential current control unit. To assure continuity, even when the power supply plug is disconnected, the basic unit is equipped with an additional PE connector (M5). This is to provide a protection from electricity arcing from the conductor rail system in case of disturbance.

The Powertrans[®] Ib unit presents a Bus unit. The Sub-D, respectively DH+ connection on the interface component, is connected by a shielded cable according to the specifications given by the PLC manufacturer.

In principle each Bus segment has to be terminated on both ends. On Profibus applications for example, the Bus terminators in the sockets have to be activated accordingly. On DH+ Bus systems, the Bus terminators have to be activated from "outside" as well.

For more information see the operating instructions of the Bus system manufacturers.

Shielding

Shielding is a method to reduce (damp) electromagnetic environmental influences.

Interference currents on cable shield are led off to ground over the shield Bus that has a conductive connection to the ground conductor.

In order to avoid that those interference currents might become a source of disturbance themselves, it is very important to provide a low-impedance connection to the protective conductor.

In general the shield of the cables should always be connected on both sides

Only a bilateral connection of the shield will allow good interference suppression in high frequencies.

The shield of the data cable is connected according to the specifications of the corresponding PLC manufacturer (often at the socket case).

Project, Assembly and Starting Operation

Standard Connection Diagram: Application Example for Half Duplex (2 poles)

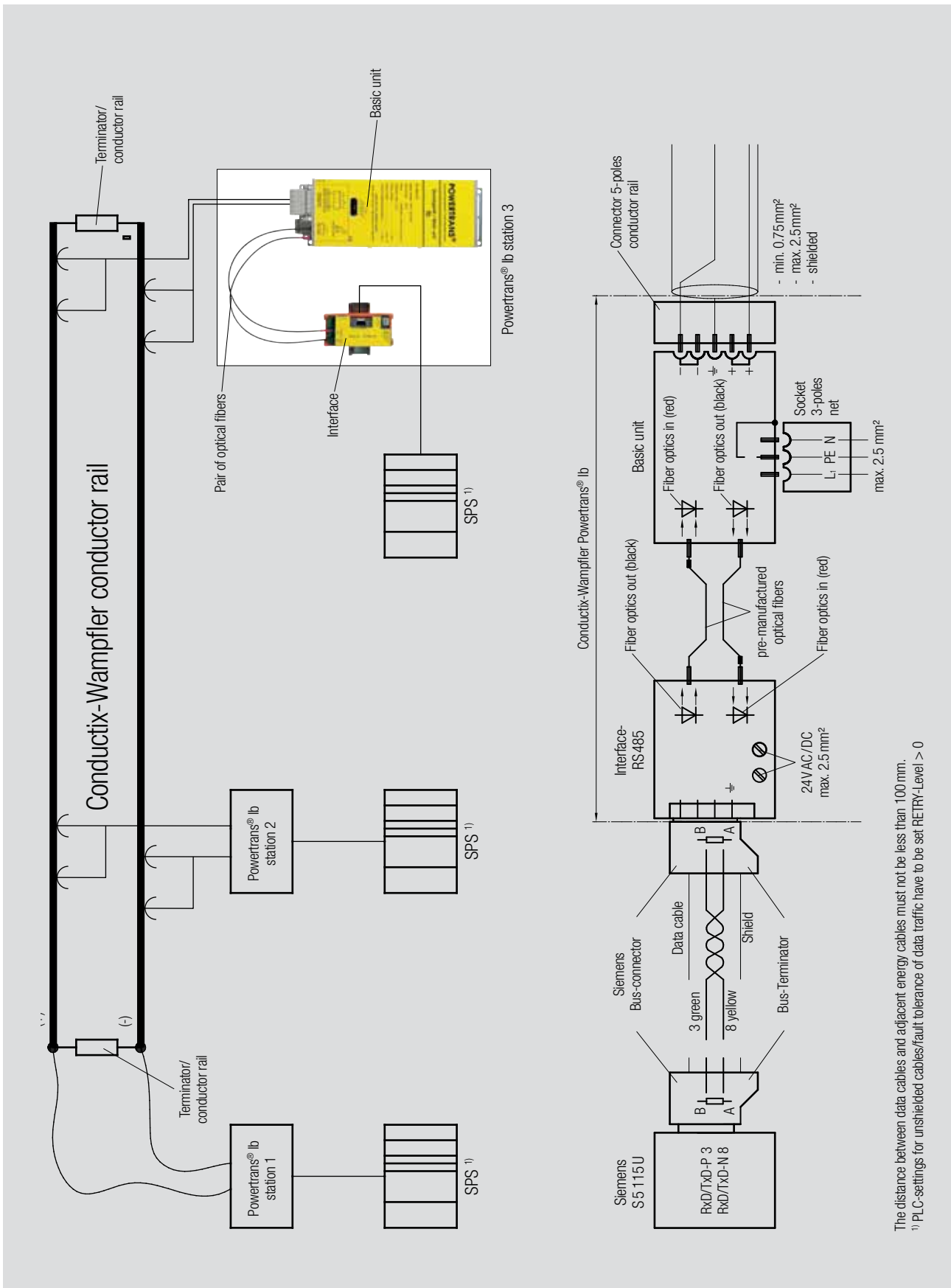

The distance between data cables and adjacent energy cables must not be less than 100 mm.
¹⁾ PLC-settings for unshielded cables/fault tolerance of data traffic have to be set RETRY-Level > 0

Project, Assembly and Starting Operation

Indicators / (LED)

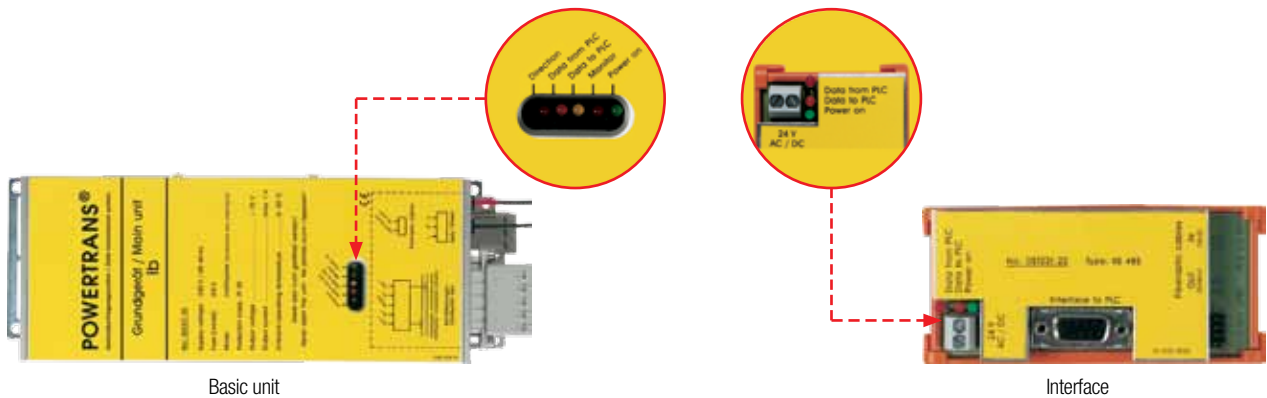

Basic unit

Interface

| Indicator / LED (Standard) | | |
|----------------------------|---------------|--|
| ● | Power | Signifies voltage supply |
| ● | Monitor | (not connected) |
| ● | Data to PLC | Signifies data out: Data from Powertrans® Ib to PLC active |
| ● | Data from PLC | Signifies data in: Data from PLC to Powertrans® Ib active |
| ● | Direction | Signifies the data flow Red shines ⇔ data flow from conductor rail to Powertrans® Ib Red does not shine ⇔ data flow from Powertrans® Ib to conductor rail LED flashes in standard operation |

Depending on the data transmission rate the LEDs will flash or shine permanently.

Indicator / LED in Case of Disturbance

| LED at | | | | Cause |
|-----------|------------------------|-----------------------|-----------|---|
| Interface | "Master" Basic unit | "Slave" Basic unit | Interface | |
| ○ ● ● | ● ● ● ● ● | ○ ● ● ● ● | ● ● ● | Conductor rail on one or several Powertrans® 1b-units with polarity reversal |
| ● ● ● | ○ ● ● ● ● | ○ ● ● ● ● | ○ ● ● | Optical fiber at the "Master"-Powertrans® with polarity reversal |
| ○ ● ● | ● ● ● ● ● | ○ ● ● ● ● | ● ● ● | Optical fiber at the "Slave"-Powertrans® with polarity reversal |
| ● ● ● | ● ● ● ● ● | ○ ● ● ● ● | ● ● ● | Supply line to the conductor rail interrupted on one or several participating units |
| ● ● ● | ● ● ● ● ● | ● ● ● ● ● | ● ● ● | Optical fiber "OUT" at the "Master" basic unit interrupted |
| ● ● ● | ○ ● ● ● ● | ○ ● ● ● ● | ● ● ● | Optical fiber "IN" at the "Master" basic unit interrupted |
| ○ ● ● | ● ● ● ● ● | ○ ● ● ● ● | ○ ● ● | Optical fiber "OUT" at the "Slave" basic unit interrupted |
| ○ ● ● | ● ● ● ● ● | ○ ● ● ● ● | ● ● ● | Optical fiber "IN" at the "Slave" basic unit interrupted |
| ○ ● ● | ○ ● ● ● ● | ○ ● ● ● ● | ● ● ● | Connection of Master-PLC at Powertrans® interrupted |
| ○ ● ● | ● ● ● ● ● | ○ ● ● ● ● | ● ● ● | Connection of Slave-PLC at Powertrans® interrupted |

Project, Assembly and Starting Operation

Cause for Disturbance

1. Voltage supply at the Powertrans® Ib basic unit/interface not available.
2. Data cable not properly connected.
3. Supply to the transmission medium not properly connected (check polarity reversal!).
4. Optical fiber not properly connected (check polarity reversal!).
5. Interruption in the transmission medium (when shutdown or in operation).
6. Terminators/conductor rail not or falsely connected.
7. Powertrans® Ib basic unit or interface defective.
8. Data traffic is interrupted (Profibus); set RETRY-Level in the PLC to > 0.

Elimination of Disturbance

1. Check voltage supply.
2. Check data cable (position of poles, connection of shielding, connection of the Bus-terminators according to the specifications of the PLC manufacturer).
3. Check supply to the conductor rail; connect shielding (see standard connection diagram).
4. See standard connection diagram.
5. Check transmission medium (e.g. conductor rails and conductors, couplers, feeding) for continuity. To short cut the transmission medium (e.g. conductor rail) the Powertrans® Ib unit can be directly connected to a two-wire cable for testing.
6. Control terminators at the beginning and end of the conductor rail.
7. Check proper function of potential equalization, voltage respectively current between "N" and "PE" must be "0".
8. For testing the interface the two interfaces can be directly connected (without the basic unit) by the optical fiber cable. For testing the basic unit the two basic units

- can be directly connected by cables instead of the conductor rail. Install replacement unit, order replacement unit at short notice if required:
- Service number (please request at Conductix-Wampfler by phone)
 - Company, contact, address
 - Order and serial number
 - Description of the fault
9. In general the transmission rate – depending on the application – should be chosen as low as possible. Adjusting the selection of response times and repeat times during the programming of the Bus-system by the operator can secure its function in particular cases.

Special Requirements for DH+ Interface Module

Recommendations for using the DH+ interface module:

1. Use at least 2 collectors on each data rail. In case of extreme or dirty environment 3 collectors are recommended. At least space for a third collector should be considered.
2. Use silver graphite collector shoes.
3. Use datametal conductor rails (stainless steel).
4. Do not use in extended temperature (beyond 0° to +50°C) or corrosive atmosphere environments.
5. Perform maintenance of collector arms, shoes and conductor rails according to the maintenance instruction of the used conductor rail type, at least every 3 month (dirty contacts and rails, contact wear, contact bounce).
6. Refer to A-B publication „Industrial Automation Wiring and Grounding Guidelines for Noise Immunity“, (Publication 1770-4.1).
7. Recommendations relating to DH+ cabling and products:
 - Limit baud rate to 57.6K or 115.2K
 - Limit DH+ cable length: 1000ft at 115.2K and 2000ft at 57.6K
 - Limit number of DH+ nodes to 16
 - Use 82Ω terminators and daisy chain routing

Note!

Some older DH+ products are not compatible with 82Ω including the following list:

- 1771-KA, KA2, KF, KX1
- 1773-KAA, KAB
- 1774-KA
- 1775-KA, GA, RM, S4A, S4B, SR
- 1784-KS
- 1785-KA3, -KE (Series A or B), -540
- 8200 products

8. Error detection should be implemented by the application: The application program or ladder logic should continually monitor communication errors and retry status (error counts and retry counts) that is provided in A-B products. Errors and retries should not normally occur. If they do, maintenance should be performed as soon as possible.
9. A device should be programmed or configured only when the device is not moving on the rails.
10. No claims are made that this equipment is appropriate for any level of safety risks. Safety protection should be provided by the application design using appropriate independent means.

Note:

„A-B“: Allen-Bradley brand of products from Rockwell Automation, a business of Rockwell International Corporation.

„DH+“, „Data Highway Plus“, Allen-Bradley“ and „PLC“ are trademarks of Rockwell Automation, a business of Rockwell International Corporation.

Project, Assembly and Starting Operation

Volume of Delivery

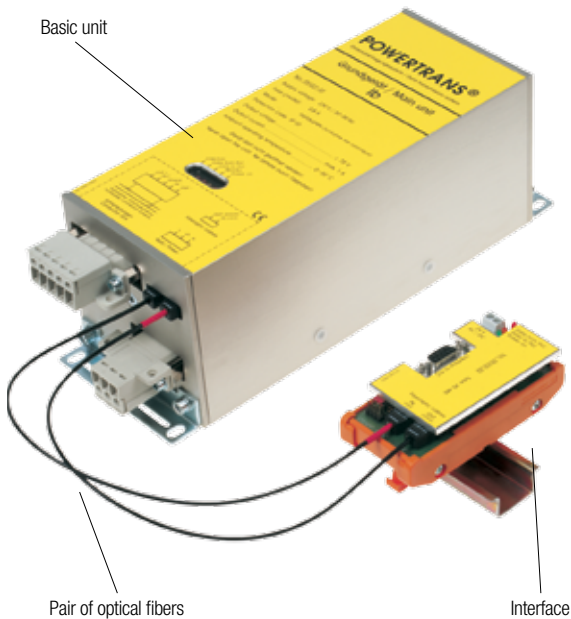

Basic unit

- 1 basic unit with socket (3 poles) for the voltage supply, socket (5 poles) for the conductor rail connection and 2 pc support brackets.
- 1 interface
- 1 pair of optical fibers pre-manufactured

Please verify immediately if the material has been delivered completely. The relevant document is the advice note.

Further Information

see instruction manual BAL0512-0001-E

Personal Security

Please consider the following topics:

- Switch off all units/machines/systems that are affected by the assembly. Disconnect these units/machines/systems from the power supply if required.
- Control the correct operation of the safety systems (e.g. emergency stop buttons)
- Install warning signs if required, to avoid starting the operation unintentionally.
- A system must only be programmed and configured while it is not in operation!

- When starting the operation make sure to apply a voltage of $\pm 70V$ on the data cables!
- After having completed the mounting/repair works, carry out a test run of the systems and check the correct operation of the safety systems!
- Only release systems that work without any fault!
- We assume that you are familiar with the appropriate knowledge of mechanics and electricity!

Equipment Security

The data transmission system fulfills the quality requirements of ISO 9001.

Powertrans® Ib units and accessories leave our company – with regard to safety technology - in a perfect condition.

Do not open the basic equipment and the interface! Opening the case affects the operational security and voids the warranty!

On Powertrans® Ib units the interface entry – and the conductor rail entry – are short-circuit proof.

Place the data and current supply cables in such a way that none of the cables will be caught during operation and that no cable will be squashed, bent or damaged in any way.

Transport Damage

Transport damage can only be claimed if the supplying company is advised immediately.

Please enclose the following documents to your return shipment:

- Service number (please request at Conductix-Wampfler by phone)
- Company, contact and address
- Order and serial number
- Description of the failure

Mounting of the Basic Unit and Interface

The support brackets of the basic unit can be fixed at the front or long side.

Basic unit and interface should be arranged in such a way that any interference from other components (e.g. frequency inverters or relay boards) will be prevented.

We recommend a minimum distance of 100 mm.

The interface must be fixed on a mounting bar TS35 (cap bar).

Questionnaire | Project Essentials

Data Transmission System Powertrans® lb Program 0512

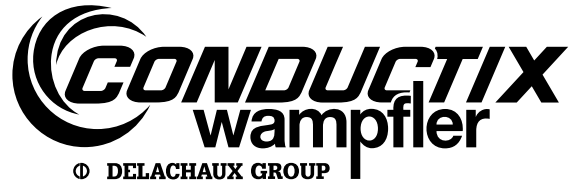

Conductor Rail / Slip Ring Body / Cables

- Conductor rail Slip ring body Cables
- ____ pcs. Point to point connections ____ pcs. Bus coupling(s) ____ pc. Master ____ pc. Slave
- Half duplex (2 poles) Full duplex (4 poles)
- Manufacturer: _____ Type central unit (Master, unit 1) Interface _____
 Manufacturer: _____ Type central unit (Slave, unit 2) Interface _____
- Data transmission speed: max. _____ kBaud
- System length: _____ min⁻¹ Travel speed: _____ m/s
 max. rotational speed: _____ min⁻¹ or peripheral speed: _____ m/s
- Cable length from current collector to Powertrans® lb unit: _____ m
- Ambient temperature: min. _____ °C max. _____ °C
- Environment: outdoor system humidity dust
 heating acid oil
 indoor system corrosive vibrations on slip ring bodies

Type of System

Please also note our questionnaire for the dimensioning of conductor rails (always on the last pages of our catalogues).

Cables

- The following interference could affect the data transmission:

- Details to the size of e.g. high voltage, high frequency:

Please Note

For complex systems please enclose a configuration drawing with dimensions of the connecting cables to your inquiry.

Customer Data

Company: _____ Customer-No.: _____

FAO: _____



Address: _____

Phone: _____ Fax: _____

E-Mail: _____

Program Overview

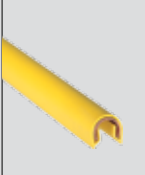
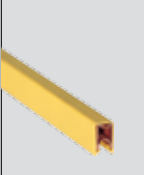
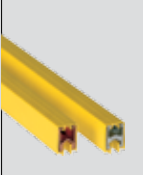
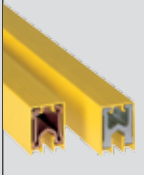
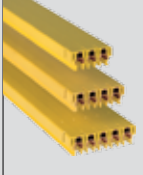
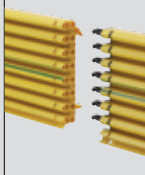
Conductor Rails

| System Designs | Single Pole Insulated Conductor Rail | | | | Multipole Conductor Rail | System Conductor Rail | Enclosed Conductor Rail |
|-------------------------------|---|---|---|---|--|---|---|
| Conductor Rail System | Progr. 0811 | Progr. 0815 | Progr. 0812 | Progr. 0813 | Progr. 0831 | EcoClickLine Progr. 0832 | Progr. 0842 |
| |  |  |  |  |  |  |  |
| Nominal Current ¹⁾ | [A] 10-100 | 100 | 25-400 | 200-1250 | 10-125 ³⁾ | 35-200 ⁴⁾ | 35-140 ⁵⁾ |
| Voltage Grade | [V] 500 | 500 | 660 | 660 | 500 | 690 | 600 |
| Support Spacing | [m] 0.4-1.0 | 0.5 | 1.5 | 2.5 | 1 | 3.2 | 2 |
| Rail Length ²⁾ | [mm] 4000 | 4000 | 4000 | 5000 | 4000 | 4000 | 4000 |
| Outside-Dimensions | [mm] 14.7 x 15.5 | 9.6 x 15.2 | 18 x 26 | 32 x 42 | 3-pole: 26 x 62 4-pole: 26 x 80 5-pole: 26 x 98 | 48 x 196 (incl. system-brackets: 50 x 220) | 5-pole: 7-pole: 56 x 90 |

1) At 100% duty cycle and 35°C; 2) Standard; 3) 140 A at 80% duty cycle; 4) Duty type S5/at 80% duty cycle 5) 160 A at 80% duty cycle

General Hints

We reserve the right to carry out any modification of the product at any time in the course of technical progress without prior notice.

All our equipment is in accordance with CE.

Our general terms of business are effective. We shall send them to you on request.

Reprint, even of extracts, is only permitted with our approval.

Your Applications – our Solutions

Powertrans® Ib Data Transmission Systems from Conductix-Wampfler represent only one of the many solutions made possible by the broad spectrum of Conductix-Wampfler components for the transport of energy, data and fluid media. The solutions we deliver for your applications are based on your specific requirements. In many cases, a combination of several different Conductix-Wampfler systems can prove advantageous. You can count on all of Conductix-Wampfler's Business Units for hands-on engineering support - coupled with the perfect solution to meet your energy management and control needs.



Cable reels

Motorized reels and spring reels by Conductix-Wampfler hold their own wherever energy, data and media have to cover the most diverse distances within a short amount of time - in all directions, fast and safe.



Festoon systems

It's hard to imagine Conductix-Wampfler cable trolleys not being used in virtually every industrial application. They're reliable and robust and available in an enormous variety of dimensions and designs.

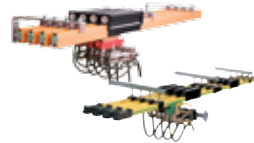

Conductor rails

Whether they're enclosed conductor rails or expandable single-pole systems, the proven conductor rails by Conductix-Wampfler reliably move people and material.



Non-insulated conductor rails

Extremely robust, non-insulated conductor rails with copper heads or stainless steel surfaces provide the ideal basis for rough applications, for example in steel mills or shipyards.



Energy guiding chains

The "Jack of all trades" when it comes to transferring energy, data, air and fluid hoses. With their wide range, these energy guiding chains are the ideal solution for many industrial applications.



Slip ring assemblies

Whenever things are really "moving in circles", the proven slip ring assemblies by Conductix-Wampfler ensure the flawless transfer of energy and data. Here, everything revolves around flexibility and reliability!



Inductive Power Transfer IPT®

The no-contact system for transferring energy and data. For all tasks that depend on high speeds and absolute resistance to wear.



Reels, retractors and balancers

Whether for hoses or cables, as classical reels or high-precision positioning aids for tools, our range of reels and spring balancers take the load off your shoulders.

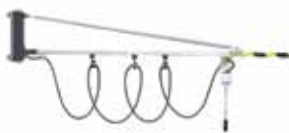

Jib booms

Complete with tool transporters, reels, or an entire media supply system – here, safety and flexibility are key to the completion of difficult tasks.



Conveyor systems

Whether manual, semiautomatic or with Power & Free – flexibility is achieved with full customization concerning layout and location.

www.conductix.com

Conductix-Wampfler GmbH

Rheinstrasse 27+33
79576 Weil am Rhein
Germany

Hotline

Phone +49 (0) 7621 662-222

Phone +49 (0) 7621 662-0

Fax +49 (0) 7621 662-144

info.de@conductix.com

www.conductix.com



DELACHAUX GROUP